

Technical data sheet

Fastening clip 1015, medium-duty

Item number: 1009362

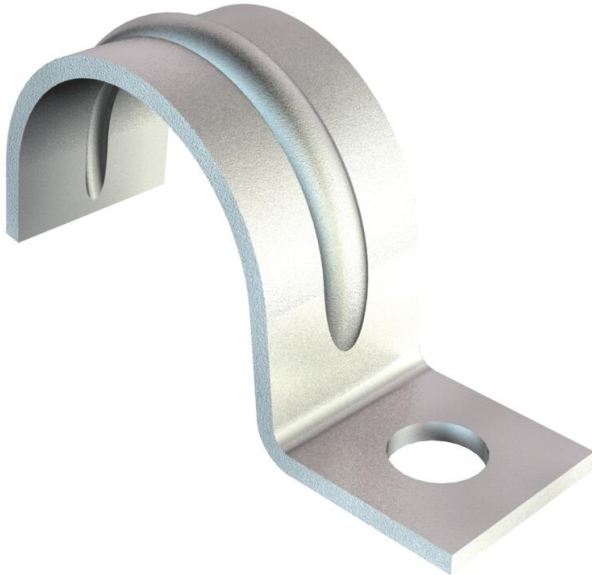

Single-lobe fastening clip for cables and pipes.
Beading from size 20.



St Steel

G Electrogalvanized

Master data

Item number	1009362
Description 1	Fastening clip
Description 2	single lobe
Manufacturer	OBO
Dimension	28mm
Material	Steel
Surface	Electrogalvanized
Surface standard	EN ISO 19598 / EN ISO 4042
Smallest sales unit	100
Unit of quantity	Piece
Weight	1.25 kg
Weight unit	kg/100 pc.

Technical data sheet

Fastening clip 1015, medium-duty

Item number: 1009362



Dimensions

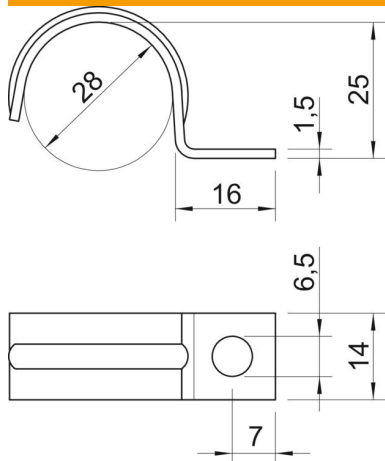

Length	16 mm
Width	14 mm
Height	25 mm
Dimension A	7 mm
Dimension b	14 mm
Dimension D	28 mm
Dimension H	25 mm
Dimension L	16 mm

Technical data

Distance to the wall	no
Number of cables/pipes	1
Version for	Single-lobe
Fastening type	Screw hole
For diameter	28
Suitable in fire protection area	no
Halogen-free	yes
Plastic-covered	no
Hole size	6,5 mm
Material thickness	1.5 mm
Nominal diameter	28 mm
UV-resistant	yes