

# Technical data sheet

## Connection thread sealing ring, metric

Item number: 2030008

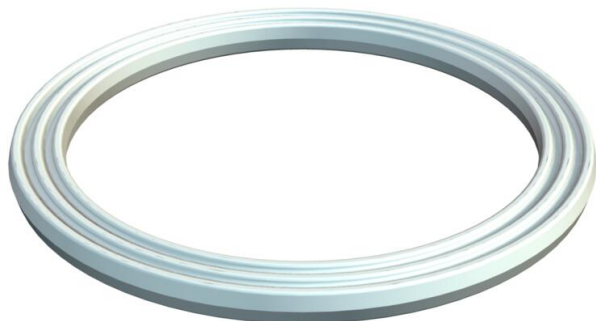

Connection thread sealing ring, suitable for all plastic cable glands, with metric thread according to DIN EN 60423 or ISO 68. The internal diameters of the sealing rings are designed in such a way that they can be pre-mounted in a captive manner.



**PE** Polyethylene

### Master data

Item number	2030008
Description 1	Connection thread sealing ring
Manufacturer	OBO
Dimension	M16
Material	Polyethylene
Smallest sales unit	100
Unit of quantity	Piece
Weight	0.015 kg
Weight unit	kg/100 pc.

### Dimensions

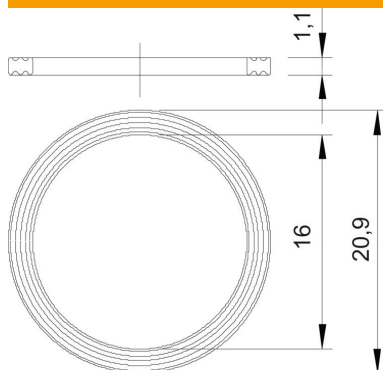

Dimension D1	20.9 mm
Dimension D2	16 mm
Dimension t	1.1 mm

### Technical data

Version for	Flat sealing ring
Suitable for metric thread dimension	16
Inner diameter	16 mm