

Technical data sheet

Locknut, metric thread

Item number: 2049511



Locknut to DIN 46319, with metric thread IEC 423.

Note: Only tighten polystyrene cable glands lightly due to the risk of stress crack formation.



PS Polystyrene

Master data

Item number	2049511
Type	116 M16 LGR PS
Description 1	Locknut
Manufacturer	OBO
Dimension	M16
Colour	Light grey; RAL 7035
Material	Polystyrene
Smallest sales unit	100
Unit of quantity	Piece
Weight	0.12 kg
Weight unit	kg/100 pc.

Technical data sheet

Locknut, metric thread

Item number: 2049511



Dimensions



Dimension E	25 mm
Dimension L	5 mm

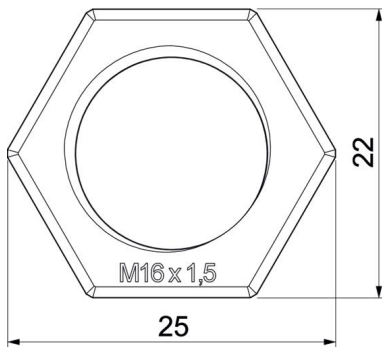

Technical data

Thread	M16_x_1,5
Thread type	Metric
Nominal thread size metric/PG	16
Fibre-glass reinforced	no
Halogen-free	yes
Impact-resistant	yes
WAF	22