

Technical data sheet

Locknut, metric thread, black

Item number: 2049112



Locknut DIN 46319, with metric thread IEC 423.



PA Polyamide

Master data

Item number	2049112
Type	116 M40 SW PA
Description 1	Locknut
Manufacturer	OBO
Dimension	M40
Colour	Black
Material	Polyamide
Smallest sales unit	25
Unit of quantity	Piece
Weight	0.602 kg
Weight unit	kg/100 pc.

Technical data sheet

Locknut, metric thread, black

Item number: 2049112



Dimensions



Dimension E	56 mm
Dimension L	7 mm

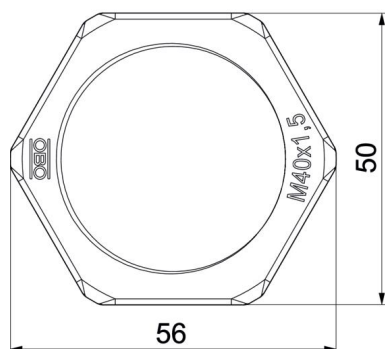

Technical data

Thread	M40_x_1,5
Thread type	Metric
Nominal thread size metric/PG	40
Fibre-glass reinforced	no
Halogen-free	yes
Impact-resistant	no
WAF	50