

# Technical data sheet

Reduction, PG thread

Item number: 2089130



Reduction (Part H) to DIN 46320, with Pg thread to DIN 40430, as a transition from a PG thread hole to a smaller cable gland.

\* Prices according to DEL notation.

CE Pg

CuZn  
37 Brass

N Nickel-plated

## Master data

Item number	2089130
Type	167 R MS PG13-11
Description 1	Reduction
Manufacturer	OBO
Dimension	PG13,5-PG11
Material	Brass
Surface	Nickel-plated
Surface standard	
Smallest sales unit	50
Unit of quantity	Piece
Weight	0.47 kg
Weight unit	kg/100 pc.

# Technical data sheet

Reduction, PG thread

Item number: 2089130



## Dimensions

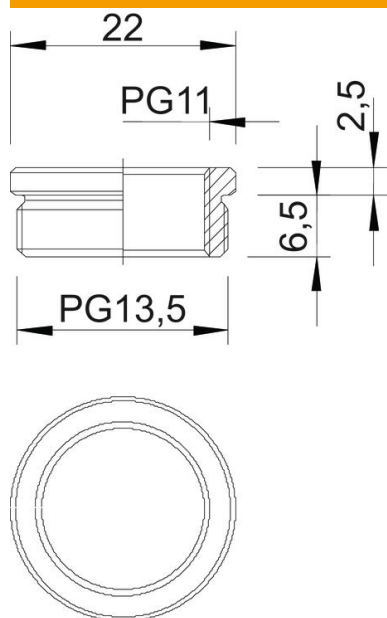

Dimension D	22 mm
Dimension L1	6.5 mm
Dimension L2	2.5 mm

## Technical data

explosion-proof	no
Thread type: External thread	PG
Thread type: Internal thread	PG
Thread length	6.5 mm
Thread dimension, PG, external	13.5
Thread dimension, PG, internal	11
Nickel-plated	yes