

Technical data sheet

Reduction, PG thread

Item number: 2089157



Reduction (Part H) to DIN 46320, with Pg thread to DIN 40430, as a transition from a PG thread hole to a smaller cable gland.

* Prices according to DEL notation.

CE Pg

CuZn
37 Brass

N Nickel-plated

Master data

Item number	2089157
Type	167 R MS PG16-9
Description 1	Reduction
Manufacturer	OBO
Dimension	PG16-PG9
Material	Brass
Surface	Nickel-plated
Surface standard	
Smallest sales unit	50
Unit of quantity	Piece
Weight	1.73 kg
Weight unit	kg/100 pc.

Technical data sheet

Reduction, PG thread

Item number: 2089157



Dimensions

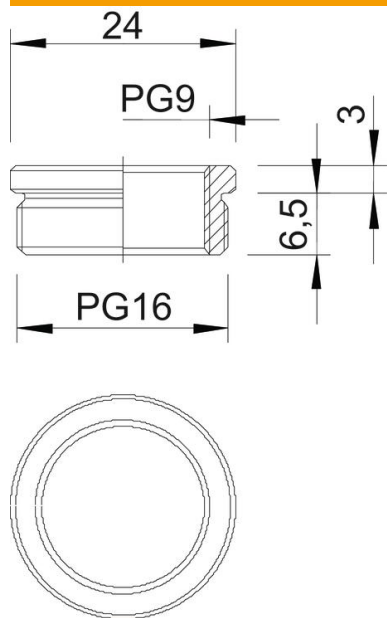

Dimension D	24 mm
Dimension L1	6.5 mm
Dimension L2	3 mm

Technical data

explosion-proof	no
Thread type: External thread	PG
Thread type: Internal thread	PG
Thread length	6.5 mm
Thread dimension, PG, external	16
Thread dimension, PG, internal	9
Nickel-plated	yes