

Technical data sheet

Reduction, PG thread

Item number: 2089335

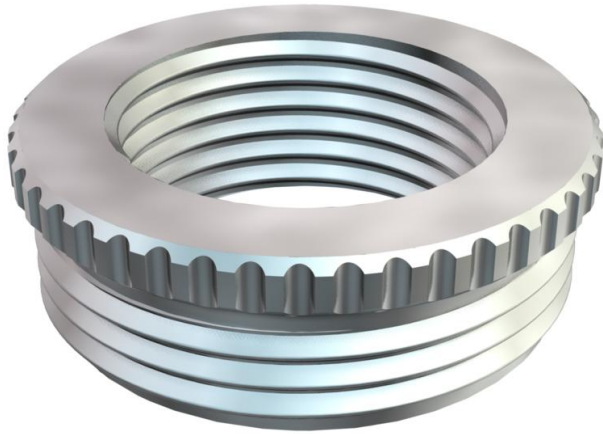

Reduction (Part H) to DIN 46320, with Pg thread to DIN 40430, as a transition from a PG thread hole to a smaller cable gland.

* Prices according to DEL notation.



CuZn
37 Brass

N Nickel-plated

Master data

Item number	2089335
Type	167 R MS PG36-21
Description 1	Reduction
Manufacturer	OBO
Dimension	PG36-PG21
Material	Brass
Surface	Nickel-plated
Surface standard	
Smallest sales unit	25
Unit of quantity	Piece
Weight	11.66 kg
Weight unit	kg/100 pc.

Technical data sheet

Reduction, PG thread

Item number: 2089335



Dimensions

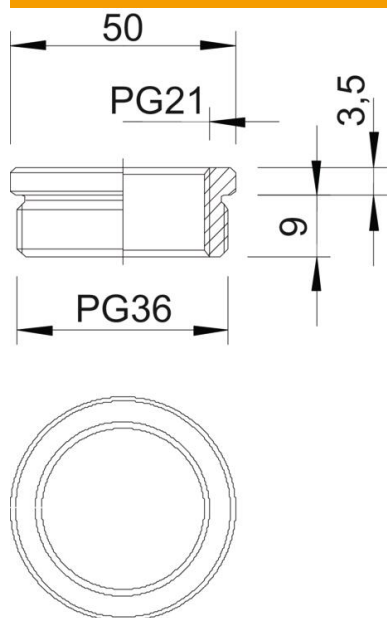

Dimension D	50 mm
Dimension L1	9 mm
Dimension L2	3.5 mm

Technical data

explosion-proof	no
Thread type: External thread	PG
Thread type: Internal thread	PG
Thread length	9 mm
Thread dimension, PG, external	36
Thread dimension, PG, internal	21
Nickel-plated	yes