

Technical data sheet

Grip collection clamp, metal 30 FS

Item number: 2207036



Metal grouped support for high mechanical stability, even in case of fire. Suitable for safe mounting above fire protection ceilings. Also approved as a cable-specific variant for the maintenance of electrical function to DIN 4102 Part 12. For wall and ceiling mounting. Lock can be opened without tools. Detailed information on the approved routing variants can be found in the appropriate testing documentation.



St Steel

FS Strip galvanized

Master data

Item number	2207036
Description 1	Grip collecting clamp
Manufacturer	OBO
Dimension	30x NYM3x1,5
Material	Steel
Surface	Strip galvanized
Surface standard	DIN EN 10346
Smallest sales unit	25
Unit of quantity	Piece
Weight	6.2 kg
Weight unit	kg/100 pc.

Technical data sheet

Grip collection clamp, metal 30 FS

Item number: 2207036



Dimensions

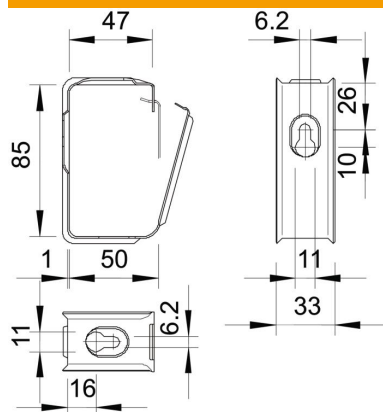

Technical data

No. of conductors NYM 3 x 1.5	30
Flame-resistant version	no
Maintain electrical functions	yes
Halogen-free	yes
With anchor	no