

Technical data sheet

Screw-in nipple, metric thread, with perforation membrane

Item number: 2032380



With perforation membranes, the opening D is pre-marked, but closed.
Grip seal to screw into metric thread to IEC 423.
With self-sealing cone at the end of the thread, therefore no connection thread sealing ring required.
Protection rating achievable with careful mounting: IP54.
With perforation membranes, the opening D is pre-marked, but closed.



PE Polyethylene

Master data

Item number	2032380
Type	90 M16 GE
Description 1	Screw-in nipple
Description 2	closed version
Manufacturer	OBO
Dimension	M16
Colour	Light grey; RAL 7035
Material	Polyethylene
Smallest sales unit	100
Unit of quantity	Piece
Weight	0.192 kg
Weight unit	kg/100 pc.

Technical data sheet

Screw-in nipple, metric thread, with perforation membrane



Item number: 2032380

Dimensions

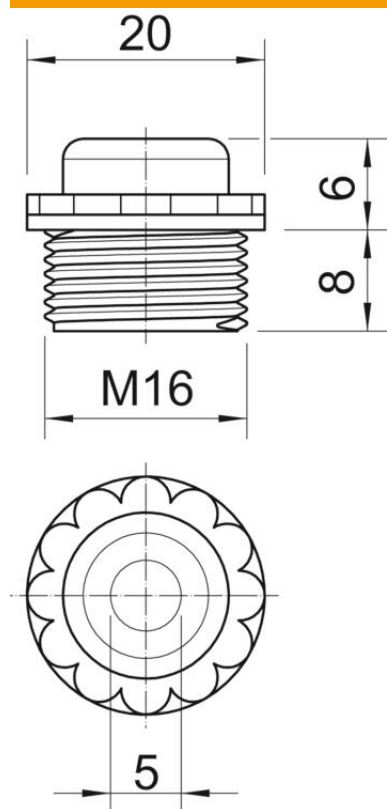

Dimension D	5 mm
Dimension E	20 mm
Dimension L1	8 mm
Dimension L2	6 mm

Technical data

Thread length	8 mm
Size	M16
Halogen-free	yes
WAF	16
Protection rating	IP54