

Technical data sheet

Screw-in nipple, metric thread, with perforation membrane

Item number: 2032386



With perforation membranes, the opening D is pre-marked, but closed.

Grip seal to screw into metric thread to IEC 423.

With self-sealing cone at the end of the thread, therefore no connection thread sealing ring required.

Protection rating achievable with careful mounting: IP54.

With perforation membranes, the opening D is pre-marked, but closed.



PE Polyethylene

Master data

Item number	2032386
Type	90 M32 GE
Description 1	Screw-in nipple
Description 2	closed version
Manufacturer	OBO
Dimension	M32
Colour	Light grey; RAL 7035
Material	Polyethylene
Smallest sales unit	25
Unit of quantity	Piece
Weight	0.694 kg
Weight unit	kg/100 pc.

Technical data sheet

Screw-in nipple, metric thread, with perforation membrane



Item number: 2032386

Dimensions

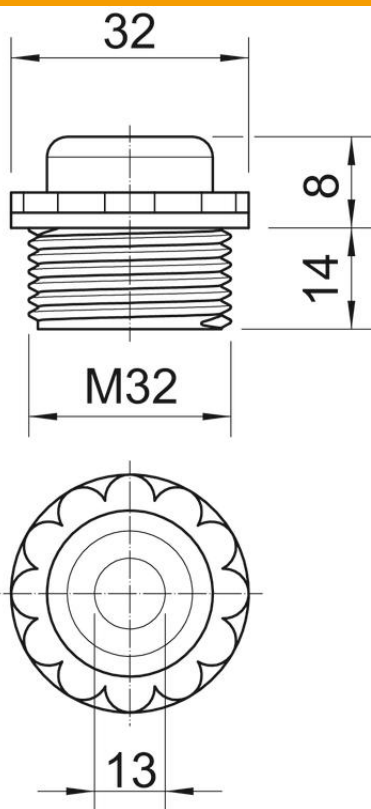

Dimension D	13 mm
Dimension E	39 mm
Dimension L1	14 mm
Dimension L2	8 mm

Technical data

Thread length	14 mm
Size	M32
Halogen-free	yes
WAF	34
Protection rating	IP54