

Technical data sheet

AML3518 anchor rail, slot 16.5 mm, A2, perforated

Item number: 1119702



Central C profile rail for cable routing, in conjunction with clamp clips with a hammerhead foot. Can also be used as suspension construction for cable support systems.



A2 Stainless steel

2B Bright, treated

Master data

Item number	1119702
Type	AML3518P2000A2
Description 1	Profile rail
Description 2	perforated, slot 16.5mm
Manufacturer	OBO
Dimension	2000x35x18
Material	Stainless steel
Surface	Bright, treated
Surface standard	
Smallest sales unit	2
Unit of quantity	Metre
Weight	82 kg
Weight unit	kg/100 m

Technical data sheet

AML3518 anchor rail, slot 16.5 mm, A2, perforated

Item number: 1119702



Dimensions

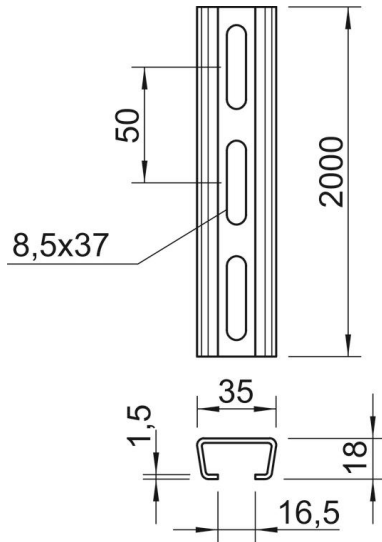

Length	2,000 mm
Width	35 mm
Height	18 mm
Dimension L	2,000 mm

Technical data

Breakable	no
Type of perforation	Perforated back
Version for	Single profile
Drill hole spacing, centre	50 mm
Bundle	20 m
Maintain electrical functions	no
Material thickness	1.5 mm
With perforation	yes
With tothing	no
Profile shape	C profile
Slot width	16.5 mm
Static value A	1.01 cm ²
Static value Iy	0.44 cm
Static value Iz	1.84 cm
Static value Wy	0.42 cm ²
Static value Wz	1.05 cm ²