

Technical data sheet

CM3015 profile rail, slot 16 mm, FT, perforated

Item number: 1109804



Profile rail, perforated, slot width 16 mm.



St Steel

FT Hot-dip galvanised

Master data

Item number	1109804
Type	CM3015P0400FT
Description 1	Profile rail
Description 2	perforated, slot 16mm
Manufacturer	OBO
Dimension	400x30x15
Material	Steel
Surface	Hot-dip galvanised
Surface standard	DIN EN ISO 1461
Smallest sales unit	10
Unit of quantity	Piece
Weight	30 kg
Weight unit	kg/100 pc.

Technical data sheet

CM3015 profile rail, slot 16 mm, FT, perforated

Item number: 1109804



Dimensions

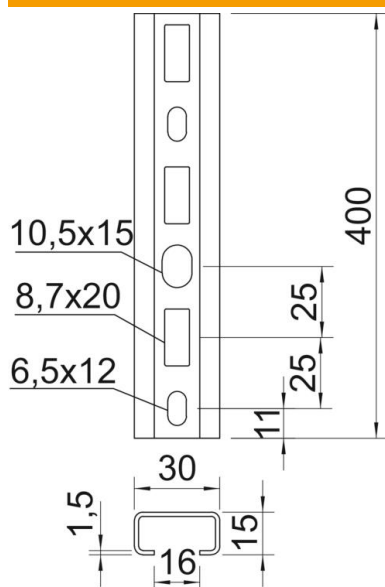

Length	400 mm
Width	30 mm
Height	15 mm
Dimension L	400 mm

Technical data

Breakable	no
Type of perforation	Perforated back
Version for	Single profile
Drill hole spacing, centre	25 mm
Maintain electrical functions	no
Material thickness	1.5 mm
With perforation	yes
With tothing	no
Profile shape	C profile
Slot width	16 mm
Static value A	0.8 cm ²
Static value Iy	0.24 cm
Static value Iz	1.22 cm
Static value Wy	0.29 cm ²
Static value Wz	0.81 cm ²