

Technical data sheet

Cover for 90° Magic bend FS

Item number: 7138506



Cover for 90° bend with premounted turn buckles.
The cover can be used with fittings of all side heights.



St Steel

FS Strip galvanized

Master data

Item number	7138506
Description 1	90° bend cover
Description 2	for bend RBM 90 300
Manufacturer	OBO
Dimension	B=300mm
Material	Steel
Surface	Strip galvanized
Surface standard	DIN EN 10346
Smallest sales unit	1
Unit of quantity	Piece
Weight	81.6 kg
Weight unit	kg/100 pc.

Technical data sheet

Cover for 90° Magic bend FS

Item number: 7138506



Dimensions

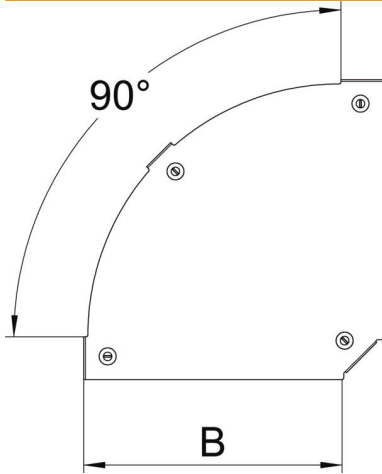

Width	300 mm
Width	12 in
Plate thickness	0.05 in
Plate thickness	1.25 mm
Dimension B	300 mm

Technical data

Bend (angle)	90°
Fastening type	Sash lock
Maintain electrical functions	no
Suitable for mesh cable tray	no
Suitable for cable ladder	yes
Suitable for cable tray	yes
Change of direction	Horizontal
Rustproof steel, pickled	no
Hinged	no