

Technical data sheet

Cover for 45° bend FS

Item number: 7128851



Cover for 45° bend with pre-mounted turn buckle.
The cover can be used with fittings of all side heights.



St	Steel
FS	Strip galvanized

Master data

Item number	7128851
Type	DFB 45 300 FS
Description 1	45° bend cover
Description 2	with sash locks, RB 45 300
Manufacturer	OBO
Dimension	B300mm
Material	Steel
Surface	Strip galvanized
Surface standard	DIN EN 10346
Smallest sales unit	1
Unit of quantity	Piece
Weight	60.2 kg
Weight unit	kg/100 pc.

Dimensions

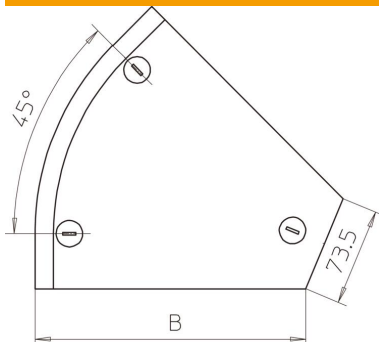

Width	300 mm
Width	12 in
Height	35 mm
Plate thickness	0.04 in
Plate thickness	1 mm
Dimension B	300 mm
Dimension H	15 mm

Technical data sheet

Cover for 45° bend FS

Item number: 7128851



Technical data

Bend (angle)	45°
Number of turn buckles	3 St.
Fastening type	Sash lock
Maintain electrical functions	no
Suitable for mesh cable tray	no
Suitable for cable ladder	no
Suitable for cable tray	yes
Change of direction	Horizontal
Rustproof steel, pickled	no
Hinged	no