

Technical data sheet

Cover for 90° bend DD

Item number: 7130619

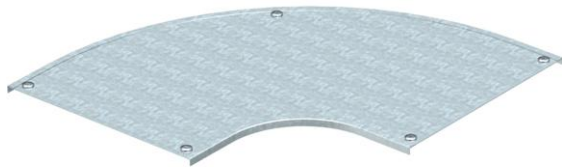

Cover for 90° bend with pre-mounted turn buckles.
The cover can be used with fittings of all side heights.



St Steel

DD Strip galvanised zinc/aluminium, Double Dip

Master data

Item number	7130619
Type	DFB 90 550 DD
Description 1	90° bend cover
Description 2	with turn-buckles, RB 90 550
Manufacturer	OBO
Dimension	B550mm
Material	Steel
Surface	Strip galvanised zinc/aluminium, Double Dip
Surface standard	DIN EN 10346
Smallest sales unit	1
Unit of quantity	Piece
Weight	607 kg
Weight unit	kg/100 pc.

Dimensions

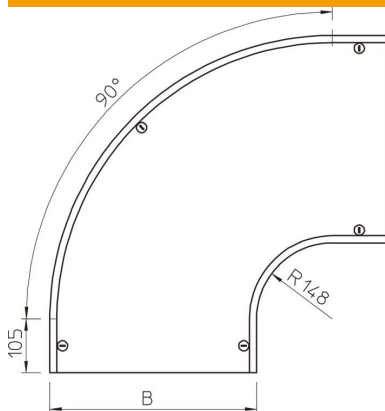

Width	550 mm
Width	22 in
Height	35 mm
Plate thickness	0.05 in
Plate thickness	1.25 mm
Dimension B	550 mm
Dimension H	15 mm
Dimension R	148 mm

Technical data sheet

Cover for 90° bend DD

Item number: 7130619



Technical data

Bend (angle)	90°
Number of turn buckles	5 St.
Fastening type	Sash lock
Maintain electrical functions	no
Suitable for mesh cable tray	no
Suitable for cable ladder	no
Suitable for cable tray	yes
Change of direction	Horizontal
Rustproof steel, pickled	no
Hinged	no