

Technical data sheet

Centre suspension mesh cable tray A4

Item number: 6015422



Centre suspension including hold-down clamp for mesh cable tray suspensions.



A4 Stainless steel

2B Bright, treated

Master data

Item number	6015422
Type	GMS 570 A4
Description 1	Centre suspension
Description 2	for mesh cable tray with clamp
Manufacturer	OBO
Dimension	B570mm
Material	Stainless steel
Surface	Bright, treated
Surface standard	
Smallest sales unit	10
Unit of quantity	Piece
Weight	67 kg
Weight unit	kg/100 pc.

Technical data sheet

Centre suspension mesh cable tray A4

Item number: 6015422



Dimensions

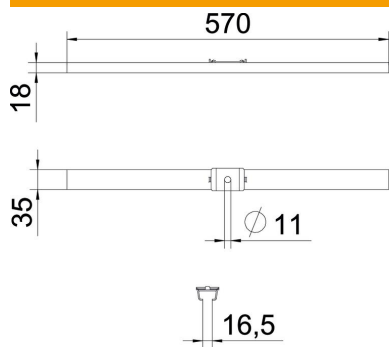

Length	35 mm
Width	570 mm
Height	18 mm
Dimension B	570 mm

Technical data

Version for	Suspended
Maintain electrical functions	no
for width max.	570 mm
for width min.	570
Suitable for metric threaded rod	10
Hole diameter	11 mm
Adjustable	no