

# Technical data sheet

## 90° mesh cable tray bend FT

Item number: 6002366



90° bend, horizontal, for all mesh cable trays of 105 mm side height.

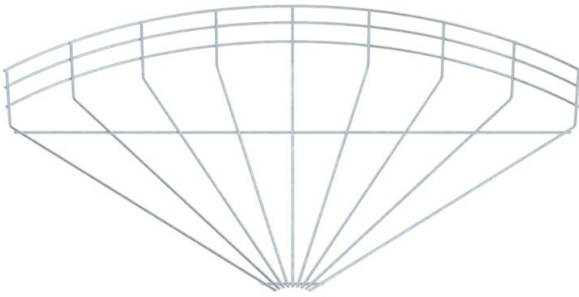

**St** Steel

**FT** Hot-dip galvanised

### Master data

Item number	6002366
Type	GRB 90 160 FT
Description 1	90° mesh cable tray bend
Manufacturer	OBO
Dimension	105x600
Material	Steel
Surface	Hot-dip galvanised
Surface standard	DIN EN ISO 1461
Smallest sales unit	1
Unit of quantity	Piece
Weight	138.4 kg
Weight unit	kg/100 pc.

# Technical data sheet

## 90° mesh cable tray bend FT

Item number: 6002366



### Dimensions

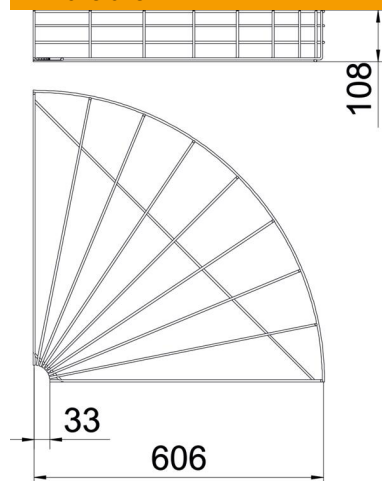

Width	600 mm
Width	23.62 in
Height	105 mm
Dimension A	33 mm
Dimension B	606 mm
Dimension H	108 mm

### Technical data

Bend (angle)	90°
Connector version	Without connectors
Type	Horizontal bend
Maintain electrical functions	no
Rustproof steel, pickled	no