

Technical data sheet

Joint connector A2

Item number: 6016642



Screwed version of joint connector for mesh cable trays.
Including screw of type FRS M6 x 20.
Figure: Positioning and quantity of mesh cable tray connectors.

50–150 mm = 2 units

200–300 mm = 3 units

400–450 mm = 4 units

500–600 mm = 5 units



A2 Stainless steel

2B Bright, treated

Master data

Item number	6016642
Type	GSV 34 A2
Description 1	Joint connector
Description 2	for mesh cable tray
Manufacturer	OBO
Material	Stainless steel
Surface	Bright, treated
Surface standard	
Smallest sales unit	20
Unit of quantity	Piece
Weight	3.1 kg
Weight unit	kg/100 pc.

Technical data sheet

Joint connector A2

Item number: 6016642



Dimensions

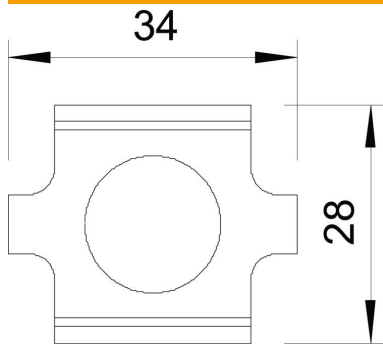

Dimension	34 x 27,5
Length	34 mm
Width	29 mm
Width	1.14 in
Height	24 mm
Height	0.94 in

Technical data

Version for	Straight connector
Maintain electrical functions	no
Suitable for mesh cable tray	yes
Suitable for cable ladder	no
Suitable for cable tray	no
Adjustable connector, horizontal	no
Articulated connector, vertical	no
Suitable for mesh cable tray wire, max.	4.9 mm
Suitable for mesh cable tray wire, min.	3.9 mm
Rustproof steel, pickled	yes
Connection type	Screw connector