

# Technical data sheet

## Adjustable bend element 110 FT

Item number: 6225516



Adjustable bend element with welded rung for use in the cable ladder types with a side height of 110 mm.

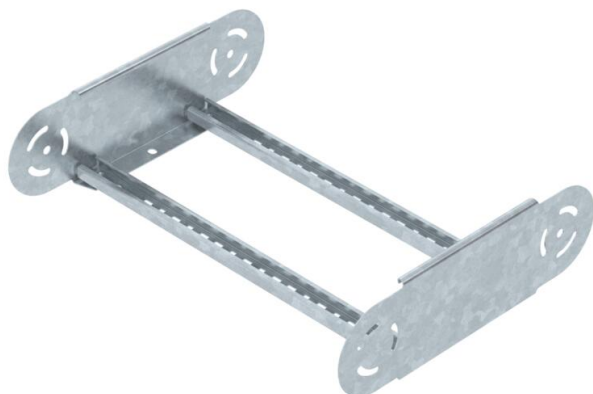

**St** Steel

**FT** Hot-dip galvanised

### Master data

Item number	6225516
Type	LGBE 1145 FT
Description 1	Adjustable bend element
Description 2	for cable ladder
Manufacturer	OBO
Dimension	110x450
Material	Steel
Surface	Hot-dip galvanised
Surface standard	DIN EN ISO 1461
Smallest sales unit	1
Unit of quantity	Piece
Weight	173.1 kg
Weight unit	kg/100 pc.

# Technical data sheet

## Adjustable bend element 110 FT

Item number: 6225516



### Dimensions

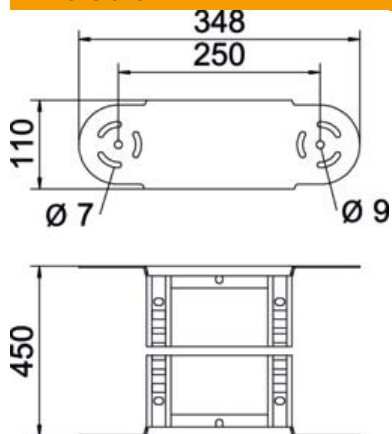

Width	450 mm
Height	110 mm
Dimension B	450 mm
Dimension R	450 mm

### Technical data

Bend (angle)	Adjustable
Version of the rungs	Profile perforated
Side rail version	Flat profile
Connector version	Integrated connector
Maintain electrical functions	no
Change of direction	Vertical, rising/falling
Rustproof steel, pickled	no
Hinged	yes
Side perforation	no
Wide-span version	no
Rail thickness	1.5 mm