

Technical data sheet

LG 60 cable ladder, 6 m VSF

Item number: 6207523



Cable ladder for the horizontal routing of cables. Can be used as a standard support structure for the maintenance of electrical functionality according to DIN 4102 Part 12. Maintenance of electrical function classes E30 to E90. With riveted C profile rung, open in an upward direction.



E30 E60 E90

St Steel

FT Hot-dip galvanised

Master data

Item number	6207523
Type	LG 620 VSF 6 FT
Description 1	Cable ladder function maint.
Description 2	rungs distance 150 mm
Manufacturer	OBO
Dimension	60x200x6000
Material	Steel
Surface	Hot-dip galvanised
Surface standard	DIN EN ISO 1461
Smallest sales unit	6
Unit of quantity	Metre
Weight	333.166 kg
Weight unit	kg/100 m

Technical data sheet

LG 60 cable ladder, 6 m VSF

Item number: 6207523



Dimensions

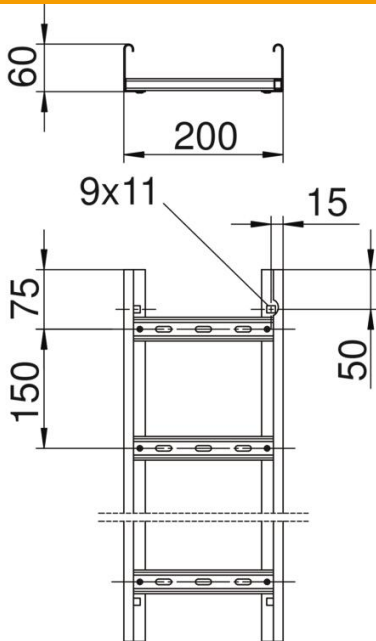

Length	6,000 mm
Length	6,000 ft
Width	200 mm
Height	60 mm
Dimension B	200 mm
Rung slot dimension	17.00

Technical data

Version of the rungs	Profile perforated
Side rail version	Profile (open)
Fastening of rung	Blind riveted
Maintain electrical functions	yes
Usable cross-section	98 cm ²
Usable cross-section	9800 mm ²
Rustproof steel, pickled	no
Side perforation	yes
Rung distance	150 mm
Wide-span version	no
Rail thickness	1.5 mm