

Technical data sheet

Cover for tee A2

Item number: 6226164



Cover with turn buckles for covering T pieces with welded rungs.



A2 Stainless steel

2B Bright, treated

Master data

Item number	6226164
Type	LTD 400 R3 A2
Description 1	Cover for T piece
Description 2	with turn buckle
Manufacturer	OBO
Dimension	B400
Material	Stainless steel
Surface	Bright, treated
Surface standard	
Smallest sales unit	1
Unit of quantity	Piece
Weight	585 kg
Weight unit	kg/100 pc.

Technical data sheet

Cover for tee A2

Item number: 6226164



Dimensions

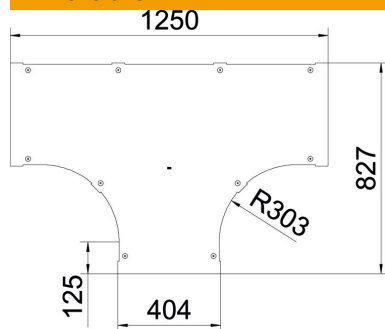

Width	400 mm
Plate thickness	1 mm
Dimension B	400 mm

Technical data

Fastening type	Sash lock
Suitable for cable ladder	yes
Suitable for cable tray	no
Material thickness	1 mm
Rustproof steel, pickled	no
Wide-span version	no