

Technical data sheet

Lock washer

Item number: 3405060



Lock washer M6

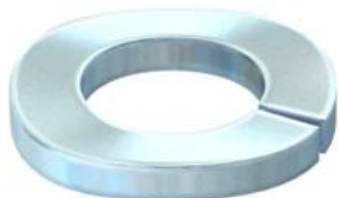

St Steel

G Electrogalvanized

Master data

Item number	3405060
Type	LWS M6 G
Description 1	Lock washer
Manufacturer	OBO
Dimension	M6
Material	Steel
Surface	Electrogalvanized
Surface standard	EN ISO 19598 / EN ISO 4042
Smallest sales unit	100
Unit of quantity	Piece
Weight	0.07 kg
Weight unit	kg/100 pc.

Dimensions

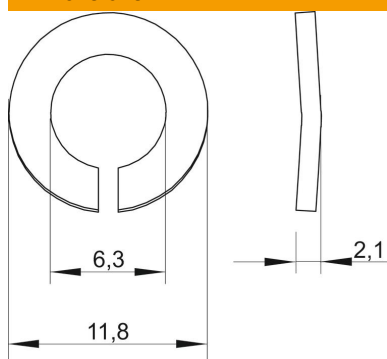

Height	2.1 mm
Plate thickness	0.08 in
Dimension D	0.46 in
Dimension d	0.25 in
Dimension d	6.3 mm
Dimension d max.	11.8 mm
Dimension d min.	11.8 mm
Dimension h	2.1 mm

Technical data

Thread	M6
Inner diameter	0.25 mm
Lock washer version	Ribbed

Technical data sheet

Lock washer

Item number: 3405060

