

Technical data sheet

Centre suspension, cable ladder FT

Item number: 6358675



Centre suspension for cable ladders.
On filling, please ensure an even load distribution (no one-sided filling).



- St** Steel
- FT** Hot-dip galvanised

Master data

Item number	6358675
Type	MAHL 400 FT
Description 1	Centre suspension
Description 2	for cable ladder
Manufacturer	OBO
Dimension	B400mm
Material	Steel
Surface	Hot-dip galvanised
Surface standard	DIN EN ISO 1461
Smallest sales unit	1
Unit of quantity	Piece
Weight	81.8 kg
Weight unit	kg/100 pc.

Technical data sheet

Centre suspension, cable ladder FT

Item number: 6358675



Dimensions

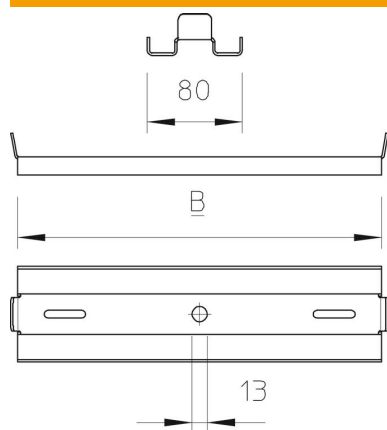

Length	80 mm
Width	400 mm
Height	15 mm

Technical data

Version for	Suspended
Maintain electrical functions	no
Suitable for metric threaded rod	12
Suitable for mesh cable tray	no
Suitable for cable ladder	yes
Suitable for cable tray	no
Tray fastening	Screw-on
Adjustable	no