

# Technical data sheet

## Mounting plate for FireBox T series

Item number: 7205484



Mounting plate for the fastening of junction boxes of the FireBox T series (with external fastening) onto cable trays or cable ladders with a side height of 60 mm. The angled construction from sheet steel reinforced through crimps enables the secure mounting of cables that maintain electrical functionality, without having to bend the cable over the side rail.

**St** Steel

**DD** Strip galvanised zinc/aluminium, Double Dip

### Master data

Item number	7205484
Type	MP T616
Description 1	Mounting plate FireBox T160
Description 2	for cable support systems
Manufacturer	OBO
Dimension	220x63x159
Material	Steel
Surface	Strip galvanised zinc/aluminium, Double Dip
Surface standard	DIN EN 10346
Smallest sales unit	1
Unit of quantity	Piece
Weight	34.5 kg
Weight unit	kg/100 pc.

# Technical data sheet

## Mounting plate for FireBox T series

Item number: 7205484

### Dimensions

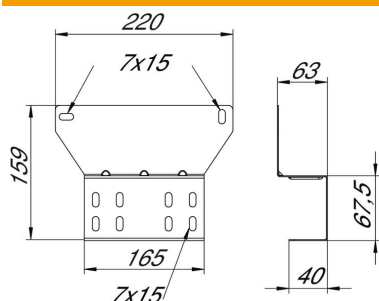

Width	220 mm
Height	159 mm
Dimension B	220 mm
Dimension H	159 mm
Dimension x	63 mm
Dimension y	165 mm

### Technical data

Version for	Horizontal
Fastening type	Screw fastening
Rustproof steel, pickled	no