

Technical data sheet

Hook-head screw ZL

Item number: 1148114



Hook-head screw for use with MS4022 profile rail



St Steel

ZL Zinc slat

Master data

Item number	1148114
Type	MS40HB M8x60 ZL
Description 1	Hook-head screw
Description 2	for profile rail MS4022
Manufacturer	OBO
Dimension	M8x60mm
Material	Steel
Surface	Zinc slat
Surface standard	
Smallest sales unit	25
Unit of quantity	Piece
Weight	6.85 kg
Weight unit	kg/100 pc.

Technical data sheet

Hook-head screw ZL

Item number: 1148114



Dimensions

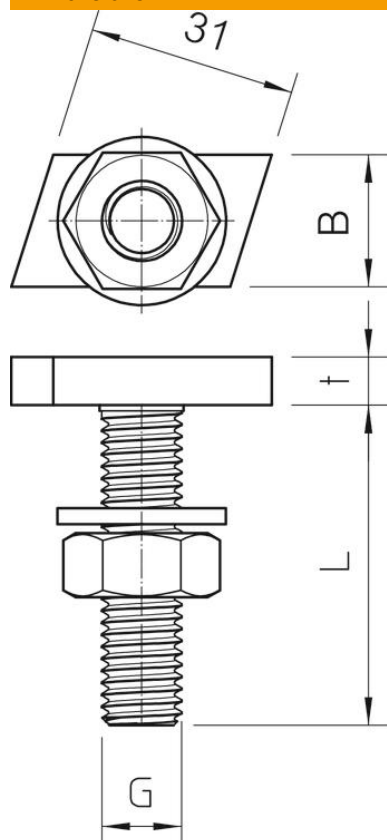

Length	35 mm
Width	17 mm
Height	10 mm

Technical data

Torque	8 Nm
Suitable for mounting rail	yes
Thread	M8x60mm
Thread metric	8