

# Technical data sheet

## MS4182 mounting rail, slot 22 mm, double, FT, perforated

Item number: 1122673



Heavy-duty profile/mounting rail with continuous perforation in base, slot width 22 mm. Double version, i.e. two profile rails are interconnected on the base (clinched).



**St** Steel

**FT** Hot-dip galvanised

### Master data

Item number	1122673
Type	MS4182P6000FT
Description 1	Profile rail
Description 2	perforated, slot 22mm
Manufacturer	OBO
Dimension	6000x41x82
Material	Steel
Surface	Hot-dip galvanised
Surface standard	DIN EN ISO 1461
Smallest sales unit	6
Unit of quantity	Metre
Weight	402.2 kg
Weight unit	kg/100 m

# Technical data sheet

MS4182 mounting rail, slot 22 mm, double, FT, perforated

Item number: 1122673



## Dimensions

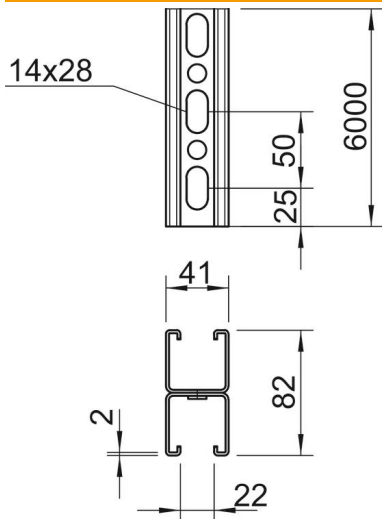

Length	6,000 mm
Width	41 mm
Height	82 mm
Dimension L	6,000 mm

## Technical data

Breakable	no
Type of perforation	Perforated bar
Version for	Double profile
Maintain electrical functions	no
Hole size	14x28 mm
Material thickness	2 mm
With tothing	yes
Profile shape	C profile
Slot width	22 mm
Static value A	4.9 cm <sup>2</sup>
Static value Iy	30.69 cm
Static value Iz	15.11 cm
Static value Wy	2.51 cm <sup>2</sup>
Static value Wz	2.69 cm <sup>2</sup>