

Konkskrui kasutamiseks profiilattidega MS4121 ja MS4141



St Teras

ZL Tsinklamell

Põhiandmed

Artiklinumber	1148322
Tüüp	MS41HB M10x30 ZL
Nimetus 1	T-kujulise peaga polt
Nimetus 2	profiilile MS4121/4141
Tooja	OBO
Mõõde	M10x30mm
Materjal	Teras
Pinnakate	Tsinklamell
Pindala standard	
Väikseim täisühik	50
Koguse ühik	Tükk
Kaal	7,4 kg
Kaaluühik	kg/100 tk

Tehniline andmeleht

T-polt ZL

Artiklinumber: 1148322



Mõõtmed

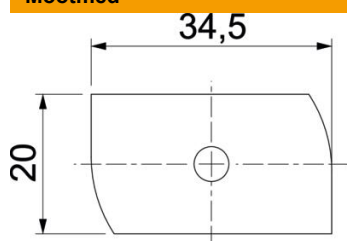

Pikkus	34,5 mm
Laius	20 mm
Kõrgus	8 mm
Mõõt H	8 mm
Mõõt L	30 mm

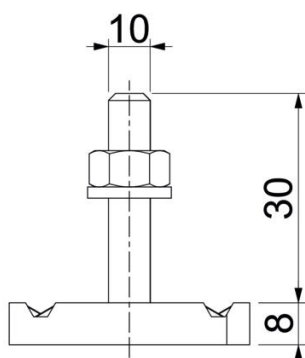

Tehnilised andmed

Pöördemoment	16 Nm
Sobib montaažiliistule	jah
Keere	M 10 x 30
Seib Ø	20 mm