

Technical data sheet

Hook-head screw A4

Item number: 1148268



Hook-head screw for use with MS5030 profile rail



A4 Stainless steel

2B Bright, treated

Master data

Item number	1148268
Type	MS50HB M10x30 A4
Description 1	Hook-head screw
Description 2	for profile rail MS5030
Manufacturer	OBO
Dimension	M10x30mm
Material	Stainless steel
Surface	Bright, treated
Surface standard	
Smallest sales unit	50
Unit of quantity	Piece
Weight	7.7 kg
Weight unit	kg/100 pc.

Technical data sheet

Hook-head screw A4

Item number: 1148268



Dimensions

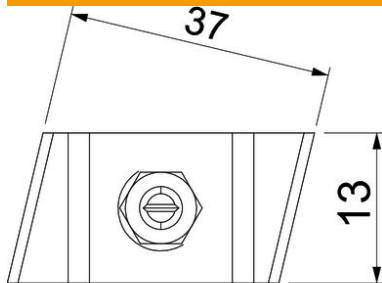

Length	43.3 mm
Width	13 mm
Height	10 mm

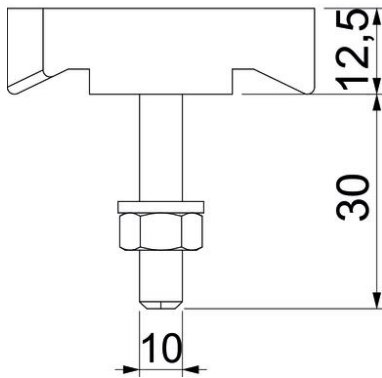

Technical data

Suitable for mounting rail	yes
Thread	M10x30mm
Thread metric	10