

# Technical data sheet

## Hook-head screw ZL

Item number: 1148214



Hook-head screw for use with MS5030 profile rail



**St** Steel

**ZL** Zinc slat

### Master data

Item number	1148214
Type	MS50HB M8x60 ZL
Description 1	Hook-head screw
Description 2	for profile rail MS5030
Manufacturer	OBO
Dimension	M8x60mm
Material	Steel
Surface	Zinc slat
Surface standard	
Smallest sales unit	25
Unit of quantity	Piece
Weight	9.9 kg
Weight unit	kg/100 pc.

# Technical data sheet

## Hook-head screw ZL

Item number: 1148214



### Dimensions

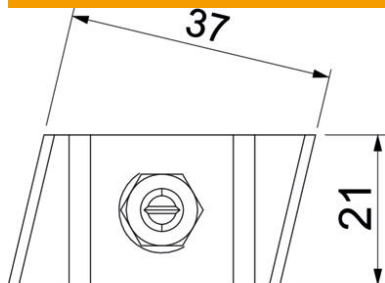

Length	43 mm
Width	21 mm
Height	12 mm

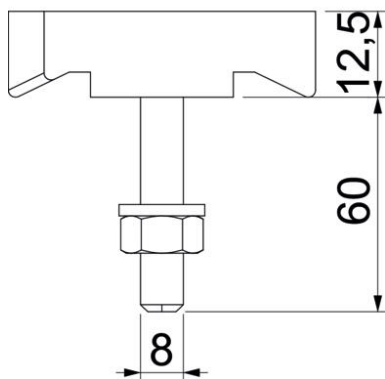

### Technical data

Suitable for mounting rail	yes
Thread	M8x60mm
Thread metric	8