

Technical data sheet

Wall and support bracket MWA 12 A2

Item number: 6424434



Light-duty wall and support bracket.
Including truss-head bolt M10 x 25 for fastening to
U supports.
Including truss-head screw M10 x 25 for fastening to
U supports.



A2 Stainless steel

2B Bright, treated

Master data

Item number	6424434
Type	MWA 12 31S A2
Description 1	Wall and support bracket
Description 2	with fastening bolt M10x20
Manufacturer	OBO
Dimension	B310mm
Material	Stainless steel
Surface	Bright, treated
Surface standard	
Smallest sales unit	1
Unit of quantity	Piece
Weight	51.8 kg
Weight unit	kg/100 pc.

Technical data sheet

Wall and support bracket MWA 12 A2

Item number: 6424434



Dimensions

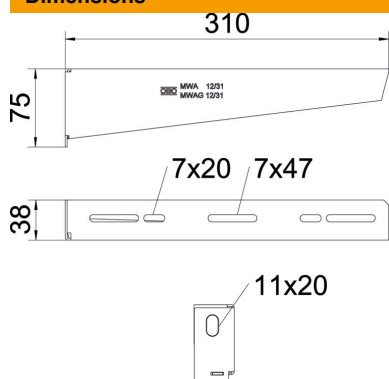

Length	38 mm
Width	310 mm
Width	12 in
Height	75 mm
Height	2.95 in
Dimension A	38 mm
Dimension B	310 mm
Dimension H	75 mm
Dimension L	310 mm

Technical data

Version for	Wall and support bracket
F in kN	1.2 kN
Maintain electrical functions	yes
Hole diameter	11 mm
Rustproof steel, pickled	no
Angle range, max.	90 mm
Angle range, min.	90 mm

Characteristic anchor load values for wall and support bracket MWA 12

Wall fastening	Max. load [kN]			
	Bracket width [mm]			
Anchor type	110	210	310	410
BZ3 10x90/0-30	1.2	1.2	1.2	1.2

Die angegebenen Werte basieren auf ungerissenen Beton der Festigkeitsklasse C20/25. Die Einbaubedingungen der ETA-Zulassung (Dübel) sind zu beachten!

Load values for MWA 12 on suspended support

Support	Max. total load F in kN			
	Bracket length in mm			
	100	200	300	400
US 3 K/ 20 - 60	1.2	1.2	1.2	1.2
US 3 K/ 70 - 120	1.2	1.2	1.2	1.2
US 5 K/ 20 - 60	1.2	1.2	1.2	1.2
US 5 K/ 70 - 120	1.2	1.2	1.2	1.2