

Technical data sheet

90° vertical bend, falling 35 FT

Item number: 7007206

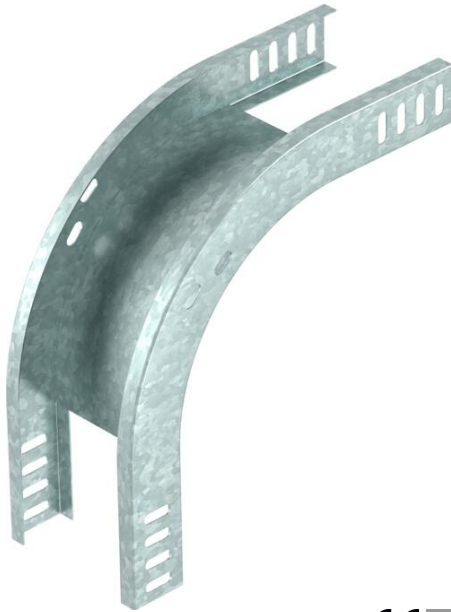

90° vertical bend, falling, for all cable tray types of 35 mm side height.

The vertical bend is pushed over the end of the cable tray and screwed tight. Fastening materials should be ordered separately.



St Steel

FT Hot-dip galvanised

Master data

Item number	7007206
Type	RBV 310 F FT
Description 1	90° vertical bend
Description 2	falling
Manufacturer	OBO
Dimension	35x100
Material	Steel
Surface	Hot-dip galvanised
Surface standard	DIN EN ISO 1461
Smallest sales unit	1
Unit of quantity	Piece
Weight	56 kg
Weight unit	kg/100 pc.

Technical data sheet

90° vertical bend, falling 35 FT

Item number: 7007206



Dimensions

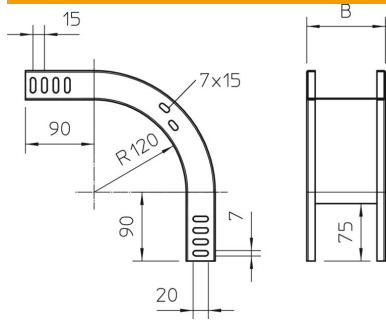

Width	100 mm
Width	4 in
Height	35 mm
Height	1 in
Plate thickness	1 mm
Dimension B	100 mm

Technical data

Bend (angle)	90°
Connector version	Without connectors
Change of direction	Vertical, falling
Type of connector, cable support system	Screwed