

Technical data sheet

45° bend 60 FS

Item number: 6043763



45° bend, horizontal, for all cable tray types of 60 mm side height.
The fitting is shipped in an unmounted state. The WKV 60 angle connector is designed for 90° bends and can be adjusted to 45° on site.
Including appropriate fastening material.



St Steel

FS Strip galvanized

Master data

Item number	6043763
Type	RB 45 610 FS
Description 1	45° bend
Description 2	horizontal + angle connector
Manufacturer	OBO
Dimension	60x100
Material	Steel
Surface	Strip galvanized
Surface standard	DIN EN 10346
Smallest sales unit	1
Unit of quantity	Piece
Weight	57.6 kg
Weight unit	kg/100 pc.

Technical data sheet

45° bend 60 FS

Item number: 6043763



Dimensions

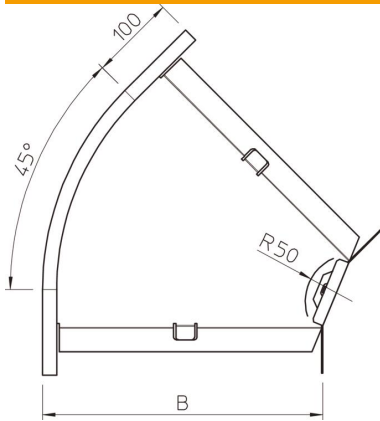

Width	100 mm
Width	4 in
Height	60 mm
Height	2 in
Plate thickness	1.25 mm
Dimension B	100 mm
Dimension R	50 mm

Technical data

Bend (angle)	45°
Connector version	Supplied connectors
Maintain electrical functions	yes
Mounting perforation in base	no
NATO hole pattern	no
Change of direction	Horizontal
Rustproof steel, pickled	no
Side perforation	no
Wide-span version	no
Type of connector, cable support system	Screwed