

Technical data sheet

90° bend 35 FT

Item number: 7124325

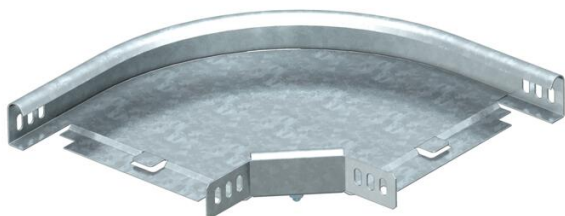

90° bend, horizontal, for all cable tray types of 35 mm side height.
The fitting is shipped in an unmounted state.
Including appropriate fastening material.



St Steel

FT Hot-dip galvanised

Master data

Item number	7124325
Type	RB 90 330 FT
Description 1	90° bend
Description 2	horizontal + angle connector
Manufacturer	OBO
Dimension	35x300
Material	Steel
Surface	Hot-dip galvanised
Surface standard	DIN EN ISO 1461
Smallest sales unit	1
Unit of quantity	Piece
Weight	150 kg
Weight unit	kg/100 pc.

Dimensions

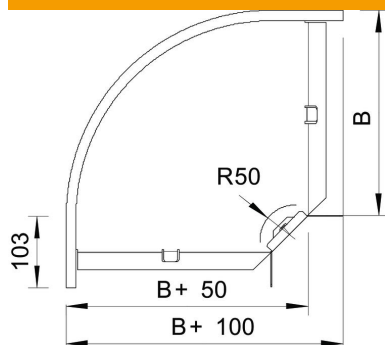

Width	300 mm
Width	12 in
Height	35 mm
Height	1 in
Dimension B	300 mm
Dimension R	50 mm

Technical data sheet

90° bend 35 FT

Item number: 7124325



Technical data

Bend (angle)	90°
Connector version	Supplied connectors
Maintain electrical functions	no
With cover	no
Mounting perforation in base	no
NATO hole pattern	no
Change of direction	Horizontal
Rustproof steel, pickled	no
Side perforation	no
Wide-span version	no
Type of connector, cable support system	Screwed