

Technical data sheet

90° bend 85 FT

Item number: 7126216

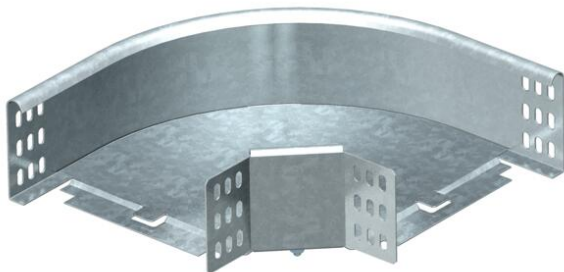

90° bend, horizontal, for all cable tray types of 85 mm side height.
The fitting is shipped in an unmounted state.
Including appropriate fastening material.



St Steel

FT Hot-dip galvanised

Master data

Item number	7126216
Description 1	90° bend
Description 2	horizontal + angle connector
Manufacturer	OBO
Dimension	85x200
Material	Steel
Surface	Hot-dip galvanised
Surface standard	DIN EN ISO 1461
Smallest sales unit	1
Unit of quantity	Piece
Weight	160 kg
Weight unit	kg/100 pc.

Dimensions

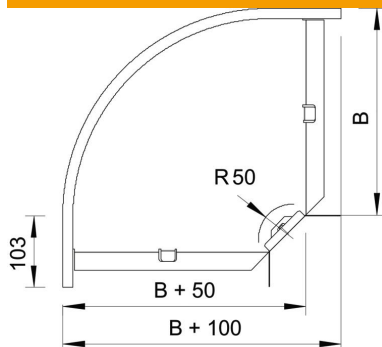

Width	200 mm
Width	8 in
Height	85 mm
Height	3 in
Dimension B	200 mm
Dimension R	50 mm

Technical data sheet

90° bend 85 FT

Item number: 7126216



Technical data

Bend (angle)	90°
Connector version	Supplied connectors
Maintain electrical functions	no
Mounting perforation in base	no
NATO hole pattern	no
Change of direction	Horizontal
Rustproof steel, pickled	no
Side perforation	no
Wide-span version	no
Type of connector, cable support system	Screwed