

Technical data sheet

Electrogalvanised steel bend, without thread

Item number: 2046814



90° bend with moulded sleeves, for electrical installation pipes according to EN 61386-1. With burr-free inner wall.



St Steel

G Electrogalvanized

Master data

Item number	2046814
Type	SBN63 G
Description 1	Conduit plug-in bend
Description 2	without thread
Manufacturer	OBO
Dimension	Ø63mm
Material	Steel
Surface	Electrogalvanized
Surface standard	EN ISO 19598 / EN ISO 4042
Smallest sales unit	3
Unit of quantity	Piece
Weight	174.2 kg
Weight unit	kg/100 pc.

Technical data sheet

Electrogalvanised steel bend, without thread



Item number: 2046814

Dimensions

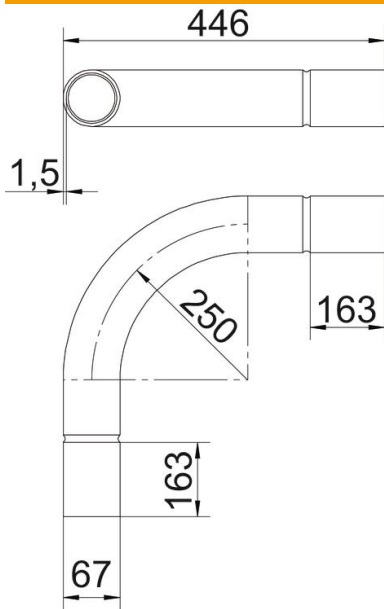

Dimension A	163 mm
Dimension B	446 mm
Dimension D	67 mm
Dimension d	64 mm
Dimension l	90 mm
Dimension m (mm)	M63
Dimension R	250 mm
Dimension t	1.5 mm

Technical data

Version for	Connector
Flexible	no
For nominal pipe diameter	63 mm
Halogen-free	no
With inspection opening and lid	no
With sleeve	yes
Brushed surface	no
Polished surface	no
Angle of the bend	90 °
Two-part	no