

Technical data sheet

Cover for 90° bend FS

Item number: 6231497

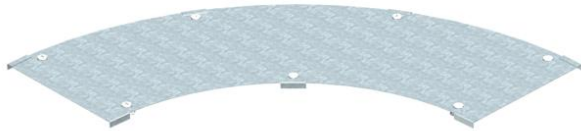

Cover for wide span 90° bend with pre-mounted turn buckles.
As the connector is mounted from the outside, the fitting cover is 300 mm shorter than the corresponding fitting. This must be considered when installing the track elements.



St	Steel
FS	Strip galvanized

Master data

Item number	6231497
Description 1	90° bend cover
Description 2	wide span system 110 and 160
Manufacturer	OBO
Dimension	B500mm
Material	Steel
Surface	Strip galvanized
Surface standard	DIN EN 10346
Smallest sales unit	1
Unit of quantity	Piece
Weight	595 kg
Weight unit	kg/100 pc.

Dimensions

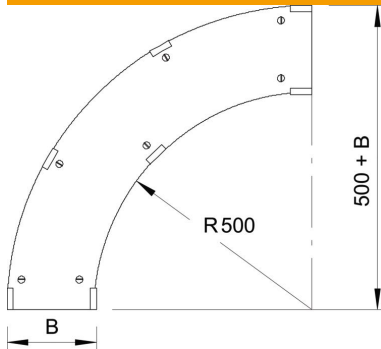

Width	500 mm
Height	110 mm
Plate thickness	1 mm
Dimension B	500 mm
Dimension H	15 mm

Technical data

Bend (angle)	90°
Number of turn buckles	7 St.
Fastening type	Sash lock
Suitable for mesh cable tray	no
Suitable for cable ladder	yes
Suitable for cable tray	yes
Rustproof steel, pickled	no