

Technical data sheet

T branch piece 200 FT

Item number: 6233678

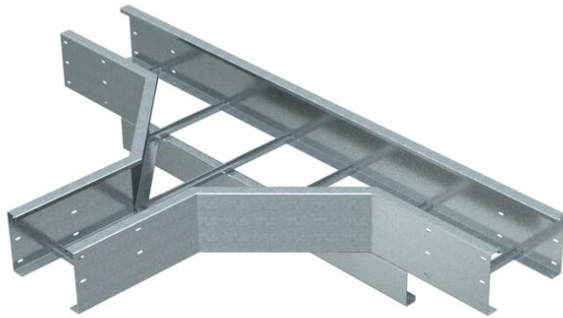

T piece, horizontal, for all wide span cable ladders of 200 mm side height.
For further stabilisation, additional supports should be planned for the area of the fittings.



St Steel

FT Hot-dip galvanised

Master data

Item number	6233678
Type	WLT 2060 FT
Description 1	T-branch piece
Description 2	for wide span cable ladder 200
Manufacturer	OBO
Dimension	200x600
Material	Steel
Surface	Hot-dip galvanised
Surface standard	DIN EN ISO 1461
Smallest sales unit	1
Unit of quantity	Piece
Weight	4308 kg
Weight unit	kg/100 pc.

Dimensions

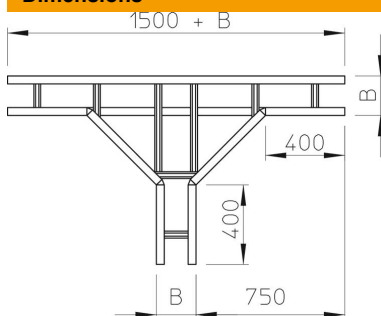

Width	600 mm
Height	200 mm
Dimension B	600 mm
Dimension R	500 mm

Technical data sheet

T branch piece 200 FT

Item number: 6233678



Technical data

Version of the rungs	Profile unperforated
Side rail version	Flat profile
Maintain electrical functions	no
Rustproof steel, pickled	no
Wide-span version	yes
Rail thickness	2.5 mm