

Technical data sheet

90° bend 160 FT

Item number: 6098746



90° bend, horizontal, for all wide span cable trays of 160 mm side height.
For further stabilisation, additional supports should be planned for the area of the fittings.



St Steel

FT Hot-dip galvanised

Master data

Item number	6098746
Type	WRB 90 166 FT
Description 1	90° bend
Description 2	for wide span cable tray 160
Manufacturer	OBO
Dimension	160x600
Material	Steel
Surface	Hot-dip galvanised
Surface standard	DIN EN ISO 1461
Smallest sales unit	1
Unit of quantity	Piece
Weight	2667 kg
Weight unit	kg/100 pc.

Dimensions

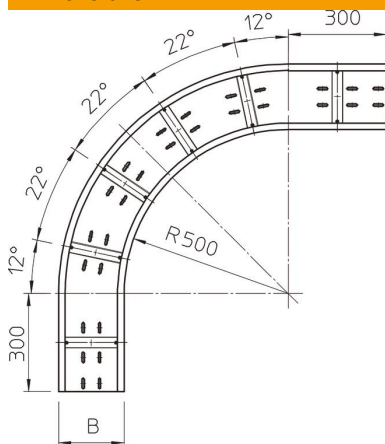

Width	600 mm
Height	160 mm
Plate thickness	2 mm
Dimension B	600 mm
Dimension R	500 mm

Technical data sheet

90° bend 160 FT

Item number: 6098746



Technical data

Bend (angle)	90°
Connector version	Without connectors
Mounting perforation in base	yes
NATO hole pattern	no
Change of direction	Horizontal
Rustproof steel, pickled	no
Side perforation	no
Wide-span version	yes
Type of connector, cable support system	Screwed